



ROYAL MALAYSIAN CUSTOMS

GOODS AND SERVICES TAX

GUIDE ON ISLAMIC BANKING

TABLE OF CONTENTS

INTRODUCTION.....	1
Overview of Goods and Services Tax (GST).....	1
GENERAL OPERATIONS OF THE INDUSTRY.....	1
GST TREATMENT ON ISLAMIC BANKING.....	2
GST treatment by supply types.....	2
(a) Exempt supplies.....	2
(b) Standard Rated Supplies.....	2
(c) Zero Rated Supplies.....	3
GST Treatment on Banking Products.....	3
(a) Accounts Operation (Savings, Current, Fixed Deposit or Other Similar Accounts).....	4
(b) Payment and Collection of Cheques.....	4
(c) Remittances.....	5
(d) Money changing activity.....	5
(e) Provision of financing, advance or credit.....	5
(f) Islamic bank cards.....	7
(g) Trade financing.....	7
(h) Imported Services.....	11
(i) Outsourcing of Services.....	11
Fixed Input Tax Recovery (FITR).....	12
FREQUENTLY ASKED QUESTIONS.....	13
FEEDBACK AND COMMENTS.....	17
FURTHER ASSISTANCE AND INFORMATION.....	17
APPENDIX I.....	i
APPENDIX II.....	xii

INTRODUCTION

1. This specific guide is prepared to assist businesses in understanding matters with regards to GST treatment on Islamic Banking.

Overview of Goods and Services Tax (GST)

2. Goods and Services Tax (GST) is a multi-stage tax on domestic consumption. GST is charged on all taxable supplies of goods and services in Malaysia except those specifically exempted. GST is also charged on importation of goods and services into Malaysia.

3. Payment of tax is made in stages by the intermediaries in the production and distribution process. Although the tax would be paid throughout the production and distribution chain, only the value added at each stage is taxed thus avoiding double taxation.

4. In Malaysia, a person who is registered under the Goods and Services Tax Act 20XX is known as a “registered person”. A registered person is required to charge GST (output tax) on his taxable supply of goods and services made to his customers. He is allowed to claim back any GST incurred on his purchases (input tax) which are inputs to his business. Therefore, the tax itself is not a cost to the intermediaries and does not appear as an expense item in their financial statements.

GENERAL OPERATIONS OF THE INDUSTRY

5. Islamic banking refers to a system of banking or banking activity that is consistent with the principles of Syariah. Thus, all dealings, transactions, business approaches, product features, investment focus and responsibilities are derived from the Syariah law. To ensure that, every such bank is required to establish a Syariah Advisory Committee. This committee is entrusted to render advice to the bank in relation to Islamic principles applicable to Islamic banking.

6. Islamic bank embraces the concept of partnership, profit and risk sharing and value-adding between banker and the customer. Among the governing principles of

an Islamic bank are the absence of interest based (*riba*) transactions, the avoidance of economic activities involving speculation (*gharar*) and gambling (*maisir*).

7. Banking services offered by Islamic banks include the business of mobilization of savings through savings, current and fixed deposits accounts, provision of various banking services and facilities for its customers including facilities to make payment, to receive money, paying or collecting of cheques drawn by or paid in by customers and the provision of finance

GST TREATMENT ON ISLAMIC BANKING

GST treatment by supply types

8. For the purpose of GST, Islamic banks normally make three types of supplies namely exempt, standard rate and zero rated supplies.

(a) Exempt supplies

Under Islamic Finance a supply is an exempt supply if the consideration of the supply is in the form of a profit charge or spread. These supplies include the provision of financing, credit or advance, exchange of currency or travellers cheques and the trading of financial options or futures.

(b) Standard Rated Supplies

A supply is a standard rated supply if there is a basic charge or a fixed fee being imposed on the supply. Fee based services are standard rated supplies. Examples of fee based services are:-

- (i) processing fee for financing
- (ii) standing instructions charges
- (iii) rental services
- (iv) counting services for coins and currency deposit
- (v) prepaid and reload charges
- (vi) maintenance services in relation to buying and selling of shares

- (vii) supply of automatic teller machine (ATM) cards and savings account books
- (viii) safe keeping or custodial services.
- (ix) intermediary services in which fees or commissions are being charged (e.g. services consisting of arranging, broking, underwriting and advising on any of the financial services).

9. However, certain fees or charges will not be subject to GST. These are fees and charges being imposed to compensate for loss, damages or to penalise the customer for not meeting certain requirements or conditions. Such penalty or fine will not be subject to GST and these penalty charges include:

- (i) late payment charges
- (ii) commitment fee (for unutilized portion of overdraft)
- (iii) compensation charge for dishonoured cheque
- (iv) overdraft excess fee.

In the case of Syariah advisory fee, it is not subject to GST.

(c) Zero Rated Supplies

Islamic banking services rendered for customers abroad will be zero-rated if at the time the services are rendered, he is outside Malaysia. Similarly, any Islamic banking service rendered in connection with land and goods situated outside Malaysia is also zero rated.

GST TREATMENT ON BANKING PRODUCTS

10. It should be noted that Islamic banking products must satisfy the syariah principle. However, one product may adopt any one (more than one) of the syariah principles. For instance, savings account can be either Wadiah or Mudharabah. For GST purposes, it is better to look at each concept/principle adopted and understand its structure and mechanism. Please refer to **Appendix I** for the GST treatment on Islamic banking products and **Appendix II** for the structure of Islamic Banking structure.

11. The treatment of some Islamic Banking products are as follows-

(a) **Accounts Operation (Savings, Current, Fixed Deposit or Other Similar Accounts)**

(i) Profit charge paid by Islamic banks as a result of deposit taking through various types of accounts is not subject to GST.

(ii) Besides rewarding the banks' customers with profit charge, banks usually charges fees for services to facilitate for the operation of these accounts. Such fees are subject to GST at standard rate. These fees may include:

- fees/charges on encashment facility
- fees/charges of Electronic Fund Transfer (EFT) and phone banking
- fees/charges on provision of Automatic Teller Machine (ATM) cards
- fees/charges on provision of bank statements
- fees/charges for issuance of cheque books
- Fees/charges on transaction via ATM or MEPS.

(b) **Payment and Collection of Cheques**

(i) The services rendered when a bank makes payment and collects a cheque is not subject to GST. However, bank charges a service fee to the drawer if a third party wishes to make cheque encashment over the counter. Similarly, bank charges fee for the service of transferring cheques. These fees are subject to GST at standard rate.

(ii) Printing of cheque books in which additional charges are imposed is also subject to GST at standard rate. Similarly, commission charged in clearing the cheques is subject to GST at standard rate.

(c) Remittances

(i) Remittance is the transfer of money from one place to another by means of cashiers' order (or bankers cheque), demand draft, mail transfer or telegraphic transfer. Remittances are not subject to GST.

(ii) Bank levies commission for the issuance of cashier's order and demand draft. The cost of telegraphic transfer which will include a commission and tele-transmission charges are subject to GST at a standard rate.

(iii) Customer may instruct his bank to affect periodic remittances to the debit of his account under the facility of standing instruction. Any fee charged is subject to GST at standard rate.

(d) Money changing

(i) Within Islamic finance, exchanging one currency for another is permissible when both parties take immediate possession of equal amounts of the counter values. The contract known as *sarf*, is a binding obligation between the counter parties to buy or sell a specified amount of foreign currency at an agreed spot exchange rate.

(ii) Money changing is the business of exchanging one currency for another, with the profit taking on the spread of currency exchange rate as income for the service and it is not subject to GST. However, in the event a service fee is charged for the currency exchange, the supply is subject to GST at a standard rate.

(e) Provision of financing, advance or credit

(i) The provision of financing, advance or credit is an exempt supply. In Islamic finance, the concept of commodity *murabahah/tawarruq* is adopted for the provision of such supply. Under this concept, there has to be an underlying asset that requires financing. The sale of an asset by the Islamic bank is an exempt supply. Any other supplies made in order to fulfil the process of financing are treated as non-supplies but input tax incurred is fully claimable.

Example:

Commodity Murabahah/Tawarruq (Tripartite Agreement Sale)

- Tawarruq is a tripartite agreement in which the financier agrees to purchase a commodity on behalf of the customer through a broker who is the commodity trader. In tawarruq, the 3 parties involved are the financier, customer and a commodities trader and this represents the free market institution.
 - For instance, the financier firstly purchases the commodity from the trader on spot basis for RM900. The financier now sells the commodity to the customer for RM1000 on deferred payment basis.
 - The customer now owns the commodity and owes the financier RM1000 on deferred payment. To obtain cash, the customer sells the commodity to the third party buyer or commodities trader. The cash obtained here acts as monetary financing element of the transaction.
- Figure 1** below is a simple diagrammatical illustration of using Tawarruq in a financing structure.

Figure 1 :Tawarruq Concept

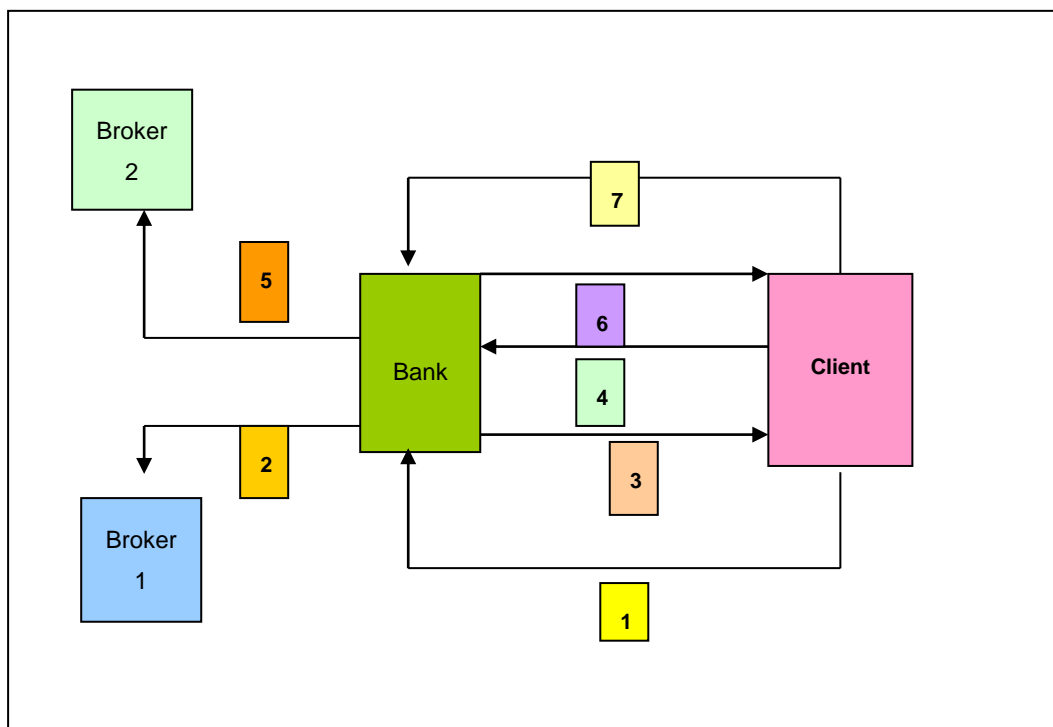

- Explanation:
 1. Bank obtains Tawarruq transaction documents from the Client
 2. Bank buys commodity from Broker 1 - (**Non Supply**)
 3. Bank sells commodity to the Client at Bank's Selling Price (Principal + profit) on deferred Term - (**Exempt Supply**)
 4. Client requests bank as its sale agent to sell commodity in the Market - (**Non Supply**)
 5. Acting as the appointed sale agent for the Client, Bank sells commodity to Broker 2 - (**Non Supply**)
 6. Bank credits Client's account with proceeds from the sale of commodity
 7. Client settles amount due to the Bank (Principal+ Profit) by way of agreed instalment method - (**Non Supply**)

(f) Islamic bank cards

- (i) Islamic bank card is the Syariah contract based credit card and is completely free from any "*riba*" or "*gharar*". There are 3 main Syariah contracts being used in the operations of Islamic bank cards i.e. Bai Inah, Wadiah and Qardhul Hassan. Some banks offer under the *tawwaruq* contract.
- (ii) Usually bank charges its customer an annual subscription fee for the usage of the card and profit charge for the granted credit. The annual subscription fee is subject to GST at standard rate while the profit charge is not subject to GST.
- (iii) Bank pays the retail outlet for the goods purchased by the customer after deducting the merchant discount commission. This discount commission is subject to GST at a standard rate. If the retail outlet is a merchant for the bank, the bank will charge rental for the usage of payments terminals and the rental is subject to GST at standard rate.

(g) Trade financing

Islamic Bank also provides facilities and services with regards to the financing in connection with either domestic or international trade. The operational

aspects of the Islamic trade finance instruments are mostly similar to the conventional except that it must conform to the Syariah requirements. Some forms of Islamic trade finance instruments are as follows-

(i) Wakalah Documentary Bills for Collection (WDBC)

- Wakalah Documentary Bills for Collection refers to the handling of commercial documents by a bank as agent whether or not accompanied by financial documents for payment, acceptance or delivery as per instructions received.
- In the case of Wakalah Outward Bills Collection, bank may act as a remitting bank by forwarding the documents received from the seller/exporter under its collection order, to the collecting bank. On the other hand, in the case of Wakalah Inward Bills Collection, bank may act a collecting bank by delivering shipping documents upon payment or acceptance by the buyer/importer.
- In both cases, bank charges collection commission. Charge is also imposed on the postage or cable usage. These commissions and charges are subject to GST at standard rate.

(ii) Wakalah Letter of Credit (WLC)

- Most of the times, the seller/exporter does not wish to ship or deliver the goods without payment or acceptable assurance of payment; while the buyer/importer does not wish to pay in advance. To overcome this problem, banks offer documentary credit facility. Wakalah Letter of Credit is a written undertaking or commitment by the issuing bank given to the seller to pay at sight or determinable future date up to a stated sum of money with prescribed time limit ,and against stipulated documents and upon compliance of terms and conditions.
- There are charges, for example, the handling fees, the acceptance commission, the advising fees and also charges on the usage of

postal and cable. These charges are subject to GST at standard rate.

(iii) Wakalah Inward Bills Under Letter of Credit (WIB)

WIB is a set of documents drawn in compliance with the terms of the seller (the beneficiary) on the bank (WLC issuing bank) for an amount, which represents full or part of the value of the goods shipped. These documents are presented to the bank through the negotiating bank and are to be checked against the terms and conditions of the WLC. There are charges and commission charged by the bank and it is subject to GST at standard rate.

(iv) Kafalah Shipping Guarantee (KSG)

KSG is an indemnity document issued by the bank addressed to a shipping company on the instruction of an importer (customer) to take delivery of the goods from the shipping company (or its agents) pending receipt of the bill of lading. Bank levies a commission for the issuance of shipping guarantee and it is subject to GST at standard rate.

(v) Kafalah Bank Guarantee (KBG)

Bank guarantee is a written obligation issued by bank to pay an agreed sum, in case the customer defaults in fulfilling his obligation. Bank acts as a guarantor and will take the responsibility to honour the beneficiary's claims. Bank levies a commission for the issuance of bank guarantee and it is subject to GST at standard rate.

(vi) Islamic Accepted Bill(IAB)

It is a facility for financing trade transactions, drawn by one party and accepted by another party where the drawer is the original creditor.

Domestic purchase is using the Murabahah contract, granted to the buyer or importer to finance their purchase of tradable goods that include raw materials, semi-finished and finished goods.

Bank appoints the customer as its agent to purchase goods on its behalf. Upon delivery of goods, Bank pays the supplier at sight or upon maturity of credit terms for the cost of the goods based on the invoice value. Bank will subsequently sell the goods to the customer on deferred payment terms at a price inclusive of the bank's profit. The deferred payment terms on sale of goods granted to the customer, constitute creation of a debt. This is securitised in the form of IAB drawn by bank. Upon maturity, the customer pays the agreed sale price of the financing.

IAB sales is a financing facility using the Bai' al-Dayn contract, granted to the seller or exporter to finance their sales or export of goods on credit. Bai' al-Dayn or debt trading is a short-term financing facility whereby bank purchases the customer's right to the debt, which is normally securitised in the form of accepted bills.

The seller or exporter, who wishes to avail him of this facility, prepares sales/export documents as required under the sale of contract and presents these documents to bank. As the sales/export documents have to be sent to the buyer, bank requests the seller/exporter to draw the IAB drawn on bank. Bank will purchase the debts and credit the proceeds to the seller/exporter. Upon receiving payment from its buyer, seller/exporter will use it to settle the AB.

The cost of banker's acceptance or IAB is made up of the acceptance commission, and it is subject to GST at standard rate.

(vii) Treasury Services

Treasury function of a bank is responsible for managing the bank's mismatch and liquidity risks, making markets to customers in forex and

sukuk, assists bank's clients in making their money market and forex exposure.

Treasury products include:

- Foreign exchange
- Capital markets & derivatives
- Structured products
- Money market
- Islamic treasury instruments

Profit earned and realized capital gains through the products are not subject to GST. However, charges in providing the services as an agent for its clients in the trading of the instrument are subject to GST at standard rate.

(h) Imported Services

Where services are received (imported) from abroad, such services are subject to GST at a standard rate if the supplies are taxable when they are made in Malaysia. In such cases, reverse charge mechanism applies as if the importer (e.g. financial institution) had supplied those services to itself. The recipient must account for the GST incurred on the taxable services. However, he is entitled to claim GST incurred on the inputs.

(i) Outsourcing of Services

Banks usually outsource their non-core activities. These outsourced services are subject to GST at standard rate. Such activities include:

- Software application development and Support services of information technology
- Payment processing and collection
- Loan management
- Credit card operations
- Cheque printing and outward clearing
- Printing and mailing services

- Property management
- Security services
- ATM cash management

FIXED INPUT TAX RECOVERY (FITR)

12. Generally, a mixed supplier has to adopt the normal rule to claim input tax which is as follows:-

- (i) Full input tax claimable if the input is wholly attributable to taxable supplies.
- (ii) Input tax is not claimable if the input is wholly attributable to exempt supplies.
- (iii) Apportioning the input tax by using the turnover method if the inputs (residual input) cannot be wholly attributable to either taxable or exempt supply.

13. The banking sector provides mixed supplies. In order to administratively ease off the tracking on huge volume of transactions. The rate in the form of a percentage determined by the Minister is used to calculate the amount of input tax allowable to be credited by banks. The allowable input tax recovery formula is given by:

$$\text{Allowable Input Tax} = \text{FITR} \times \text{Input Tax}$$

The total input tax incurred in the taxable period includes:

- (a) input tax in relation to exempt supplies i.e. loans provided to businesses and individuals;
- (b) input tax in relation to standard rated and zero rated supplies;
- (c) input tax in relation to other exempt supplies e.g. investment activities.

14. For Islamic banks and other financial institutions making financial supplies in accordance with the principles of Syariah, the input tax incurred on the purchase or acquisition of assets directly attributable to a supply of financing in

compliance with the principles of Syariah is fully claimable. The following example shows the calculation for input tax recovery by such banks and financial institution-

Example:

In the taxable period of January 2016, ABC Islamic Bank incurred GST on the following:

- (a) input tax incurred on the acquisition of commodities for the purpose of Syariah financing - RM15,000
- (b) input tax on standard rated supplies(fee based services)
- RM 36,000
- (c) input tax on investment activities - RM12,000

For the year 2016, an Islamic bank is allowed to use a fixed rate at 70% for the purpose of claiming input tax.

$$\begin{aligned}\text{Input Tax Claimable} &= \text{Input Tax incurred in the taxable period} \times \text{FITR rate} \\ &= (\text{RM}36,000 + \text{RM}12,000) \times 70\% \\ &= \text{RM}33,600\end{aligned}$$

For the taxable period of January 2016, the Islamic bank is allowed to claim input tax amounting to:

$$\text{RM}33,600 + \text{RM}15,000 = \text{RM}48,600$$

FREQUENTLY ASKED QUESTIONS

GST Registration

Q1: Most of the financial services are not subject to GST. Do Islamic banks and Islamic financial institutions need to be registered?

A1: Even though most of the financial services are not subject to GST, Islamic banks and Islamic financial institutions provide fee-based services which are subject to GST at standard rate. If the amount of these taxable supplies

exceeds the prescribed threshold, then it is a mandatory requirement for the Islamic banks or Islamic financial institutions to be registered under GST.

Q2: Can several banks under the same holding company be registered under group registration?

A2: No. GST Group registration is restricted to businesses which makes wholly taxable supplies. Banks being suppliers of exempt supplies are not eligible for GST group registration.

Tax Invoices

Q3: My customers perform many banking transactions in a taxable period. Should I issue a tax invoice for every banking transaction?

A3: No, you need not issue a tax invoice for every transaction. You can apply to the Customs Department for approval to issue a monthly statement covering every banking transaction that has taken place within the calendar month.

Q4: Should I issue a tax invoice to an individual customer who is a non-registered person?

A4: Generally, a registered person must issue a tax invoice in respect of taxable supply. If there is no taxable supply, then it is not required. The bank can apply to the Customs Department for approval to be exempted from issuing a tax invoice to a non- GST registered person. However, the bank is required to issue serially numbered receipts for audit purposes. Alternatively, instead of issuing receipts manually, electronic receipting is also allowed, as long it is captured and recorded.

Q5: Do I have to issue tax invoice for transactions involving customers abroad with zero-rated supplies?

A5: You need not issue a tax invoice for a zero-rated supply.

Input Tax Recovery

Q7: Can I claim input tax incurred in respect of medical and hospitalisation benefits for my employees?

A7: No, the Islamic bank is not entitled to claim the input tax incurred because medical and hospitalisation benefits for the employees as these are blocked inputs.

Q8: In December 2016, I organize an annual dinner for the employees at a hotel. Existing clients are also invited for the dinner. Can I claim input tax incurred for the dinner?

A8: Yes, you are entitled to claim input tax on business entertainment to employees and existing clients.

Accounts operation (savings, current, fixed deposit or other similar accounts)

Q9: When a customer deposits or withdraws money from his savings, fixed deposit or current account, is he subject to GST?

A9: Deposits or withdrawals from the savings, fixed deposit or current account are not subject to GST.

Q10: Is profit charge subject to GST?

A10: No, profit charge is not subject to GST.

Q11: I charge my customers certain fees such as half yearly service charge for current account and fifth cash ATM withdrawal charge. Are they subject to GST?

A11: Yes, these charges are subject to GST. Any fee based charge in the form of explicit fees imposed by any bank or financial institution are subject to GST.

Provision of financing, advances or credits

Q12: Is the provision of financing subject to GST?

A12: When a bank provides financing to its customer, the bank would enjoy profits. The profit charge with regards to the provision of financing is not subject to GST. However, any fees or charges in relation to it, for instance processing fee, advisory services fee or charges on making copies on the document are subject to GST.

Q13: Are repayments of the principal amount subject to GST?

A13: The repayment of financing, i.e. the installment of the principal amount with or without profit charge is also not subject to GST

Q14: Is late payment penalty subject to GST?

A14: No. Late payment penalty is not subject to GST.

Q15: I provide financing to a project in Vietnam. Will this financing be subject to GST?

A15: Financing a project outside Malaysia is zero-rated and its processing fee in respect of the financing given is also zero rated.

Credit, Debit or Charge Card

Q16: Most banks waive the annual subscription fee on the credit card to make it competitive in the market. Is GST still be imposed on the waived annual subscription fee?

A16: Since there is no consideration for the supply of service, the bank need not charge GST on the waived annual subscription fee.

Documentary Credit

Q17: As an advising bank, I charge a confirmation commission for confirming an LC in favour of a Malaysian exporter. Is this commission subject to GST?

A17: This commission is subject to GST as the service is performed in Malaysia.

Q18: I issue a letter of credit to a local trader for an importation of goods and charge a fee for the issuance of the letter of credit. What is the GST treatment on this fee?

A18: Such fee is subject to GST at standard rate

Q19: I also provide advisory service in relation to the issuance of the letter of credit. Is advisory service subject to GST?

A19: Advisory service is a taxable supply and is subject to GST at standard rate.

Foreign Exchange

Q20: What is the GST treatment on foreign currency exchange?

A20: Bank profits from spread resulting from the difference between the rates of selling and buying of the currency. Spread is not subject to GST.

Q21: What is the GST treatment on the fee or commission charged on the issuance and encashment of traveller's cheque within Malaysia?

A21: The fee or commission is subject to GST at standard rate

Safe Keeping And Custodial Service

Q22: What is the GST treatment on safe keeping and custodial services?

A22: Bank provides safe-keeping or custodial services to its customer by offering a safety deposit box and charges rental on the box. The rental charges are subject to GST at standard rate.

FEEDBACK AND COMMENTS

10. Any feedbacks or comments will be greatly appreciated. Please email your feedbacks or comments to either Mohd Hisham B. Mohd Nor (m_hisham.nor@customs.gov.my) or Aminul Izmeer B. Mohd Sohaimi (izmeer.msahaimi@customs.gov.my).

FURTHER ASSISTANCE AND INFORMATION

11. Further information can be obtained from:

- (a) GST Website : www.gst.customs.gov.my
- (b) GST Hotline : 03-88822111
- (b) Customs Call Centre :
 - Tel : 03- 7806 7200/ 1-300-888-500
 - Fax : 03- 7806 7599
 - E-mail : ccc@customs.gov.my

APPENDIX I

Islamic Banking Products and GST Treatment

PRODUCTS/TRANSACTIONS TREATMENT VALUE

SOURCE OF FUNDS – DEPOSITS

A WADIAH – SAVINGS ACCOUNT

A01	request for account statement provides statement requested by customer	standard	service fee
A02	replacement of passbook replacement due to lost and poor handling	standard	service fee
A03	early closure of account Customer closes his account within a few months of opening e.g. customer is charged if he closes his account within 3 months of opening	standard	service fee
A03	Inter branch online transaction	standard	commission
A04	transfer funds by instruction	standard	transfer fee
A05	dormant account	standard	service fee

PRODUCTS/TRANSACTIONS	TREATMENT	VALUE
transfers in active balance to BNM		
A06 dormant account – notice advises customer that account is deemed inactive	standard	service fee
A07 dormant account –maintenance Maintain and monitor the inactive account with the balance of more than RM 10.	standard	service fee
B WADIAH - CURRENT ACCOUNT		
B01 current account -maintenance maintenance of current account	standard	annual fee
B02 opening of account searching through Suruhanjaya Syarikat Makaysia (SSM) and CTOS	standard	search fee
B03 early closure of account Customer closes his account within a few months of opening .e.g. customer is charge if he closes his account within 3 months of opening	standard	service fee
B04 withdrawal transaction After a specified number of onwards transactions per month. eg. 1 st . to 5 th transaction over the counter	standard	transaction fee

PRODUCTS/TRANSACTIONS	TREATMENT	VALUE
are for free, but 6 th onwards are charge		
B05 Inter branch current account withdrawals	standard	commission
B06 request for statement/ad hoc statement	standard	service fee
B07 dishonored cheques Due to insufficient funds, post dated cheque, honouring pending cheque.	standard	service fee
B08 stop payment instruction	standard	service fee
B09 issuance of cheque book sale of personalized cheque to customer	standard	service fee
B10 dispatch of check book upon request	standard	service fee
B11 request for photocopy of cheques make a copy of the cheque image	standard	service fee
B12 third party cheque encashment	standard	commission
B13 appointment of mandatee appoints mandatee to operate an account	standard	service fee
B14 overdrawn current account eg. due to insufficient fund and covered before the cut off time for return cheque	standard	service fee
B15 uncollected cheque books	standard	service fee

	PRODUCTS/TRANSACTIONS	TREATMENT	VALUE
	cheque books which are not collected have to be destroyed		
B16	reconciliation services service consisting of sorting and listing of cheque, and details of cheque cashed and still outstanding	standard	service fee
B17	Inter branch online transaction	standard	commission
B18	transfer of funds by instruction	standard	transfer fee
B19	dormant account transfers in active balance to BNM	standard	service fee
B20	dormant account – notice advices customer that account is deemed inactive	standard	service fee
B21	dormant account –maintenance maintain and monitor the inactive account with the balance of more than RM 10	standard	service fee
C	MUDHARABAH – GENERAL INVESTMENT ACCOUNT (GIA)		
C01	issuance of duplicate GIA receipt	standard	service fee
C02	replacement of GIA receipt	standard	service fee

	PRODUCTS/TRANSACTIONS	TREATMENT	VALUE
D	ATM BANKCARD		
D01	bankcard usage	standard	annual fee
D02	card replacement	standard	service fee
D03	cash withdrawals at MEPS	standard	commission
D04	bill payment through ATM	standard	commission

APPLICATION OF FUNDS – FINANCING

E	ASSET BASED FINANCING		
E01	IJARAH – LEASING		
	facility through leasing	standard	rental
E02	IJARAH WA IQTINA – LEASING AND OWNERSHIP		
	facility through leasing	standard	rental
	selling the asset upon expiry of leasing contract for ownership	standard	selling price

	PRODUCTS/TRANSACTIONS	TREATMENT	VALUE
E03	IJARAH THUMMA BAI – LEASING / HIRE PURCHASE		
	facility through leasing	standard	rental
	selling the asset upon expiry of leasing contract for purchasing	standard	selling price
E04	BAI BITHAMAN AJIL – DEFERRED PAYMENT INSTALLMENT SALE		
	selling the asset with deferred payment facility	exempt	profits
E05	MURABAHAH – WORKING CAPITAL FINANCING		
	selling the goods on deferred term	exempt	profits
E06	ISTISNA – PROJECT FINANCING		
	selling the property with deferred payment facility	exempt	profits
E07	MUSYARAKAH MUTANAQISAH – EQUITY FINANCING		
	gradual sales of equitable interests along with leasing	exempt	profits
E08	COMMODITY MURABAHAH		
	selling the commodity	exempt	profits

PRODUCTS/TRANSACTIONS	TREATMENT	VALUE
E08 OTHERS UNDER FINANCING		
i application and processing - perform work related to granting loan	standard	processing fee
ii conversion - changes and revise original terms and conditions of loan	standard	conversion fee
iii management - for management of loan ie. arrangement/advisory	standard	management fee
iv transfer - transfer credit to another lender	standard	transfer fee
v assignment - transfer title to property or other right	standard	transfer fee
vi renewal - re-grants a credit after original maturity reached	standard	re-schedule fee
vii restructuring - restructure loan facility eg. for SME loan	standard	restructuring fee
vii syndication - Al-ujr – fee for syndication services	standard	syndication fee
F TRADE FINANCING		
F01 MURABAHAH FUNDING WITH LETTER OF CREDIT		
issuance of Letter of Credit (LC)	standard	commission
selling goods with deferred payment	exempt	profits

	PRODUCTS/TRANSACTIONS	TREATMENT	VALUE
	facility		
F02	WAKALAH – LETTER OF CREDIT		
	issuance of LC	standard	commission
F03	KAFALAH – BANK AND SHIPPING GUARANTEE		
	issuance of BG	standard	commission
	issuance of SG	standard	commission
G	REMITTANCE		
G01	cashier order –issuance	standard	commission
G02	demand draft – issuance	standard	commission
G03	demand draft – unrepresented process and investigate	standard	handling fee
G04	demand draft –stop payment	standard	service fee
G05	demand draft –request to replace request to replace or refund stale DD	standard	replacement fee
G06	banker acceptance –issuance	standard	commission
G07	travellers cheque – sale sells travellers cheque	standard	commission

	PRODUCTS/TRANSACTIONS	TREATMENT	VALUE
G08	travellers cheque – encashment	standard	commission
G09	telegraphic transfer transfers fund by mail or wire	standard	commission
G10	EFT/POS credit credits merchant's account with fund transferred from client account thru EFT	standard	commission
G11	foreign worker remittance	standard	commission
G12	standing instruction	standard	commission
H	SAFEKEEPING		
H01	safe deposit box –rental rental of safety deposit box	standard	rental fee
H02	safe deposit box – listing of contents lists the contents of a safety deposit box when a box is opened by bank (eg. if client dies, bank often requested to open and list contents for estate purposes)	standard	service fee
H03	safe deposit – appointment of mandate to access	standard	service fee
H04	safe deposit – key deposit	standard	service fee
H05	safe deposit – duplicate key	standard	service fee

	PRODUCTS/TRANSACTIONS	TREATMENT	VALUE
	replaces or duplicates box key		
H06	safe deposit box - drilling opens a safety box if the key is lost	standard	service fee
H07	coin deposits and changing	standard	commission
H08	purchase/sale of foreign currency buys and sells currency	standard	commission
H08	foreign currency conversion convert one currency into another	standard	commission
I	BAI INAH – ISLAMIC CREDIT CARD		
I01	issuance of credit card	standard	annual fee
I02	cash advance allows cardholder to draw cash	exempt	interest
I03	late payment	exempt	interest
I04	card replacement	standard	service fee
I05	statement retrieval	standard	service fee

	PRODUCTS/TRANSACTIONS	TREATMENT	VALUE
J01	Dealings in Financial Instruments and Shares		
	sale, transfer or receipt of bond, certificate of deposit, shares and stocks, government bills	exempt	spread
	Intermediary charges for arranging the deal	standard	commission
	Underwriting of share and stock issues	standard	commission
J02	Underwriting Financial Instruments		
	Fee in the form of discount on the market value of the financial instrument.	standard	Underwriting fees
J03	Debt Collection	standard	commission
J04	Debt Factoring	standard	Factoring fee
J05	Financial Advisory Services	standard	Advisory fees
J06	Fund Management		
	Management fee on the provision of management services of collective investment fund, investment portfolio or private fund.	standard	Management fee
	Transaction-based fee for buying and selling of securities	standard	fees

APPENDIX II

Figure 1 : Structure of Murabahah and Bai Bitamin Ajil (BBA) financing .

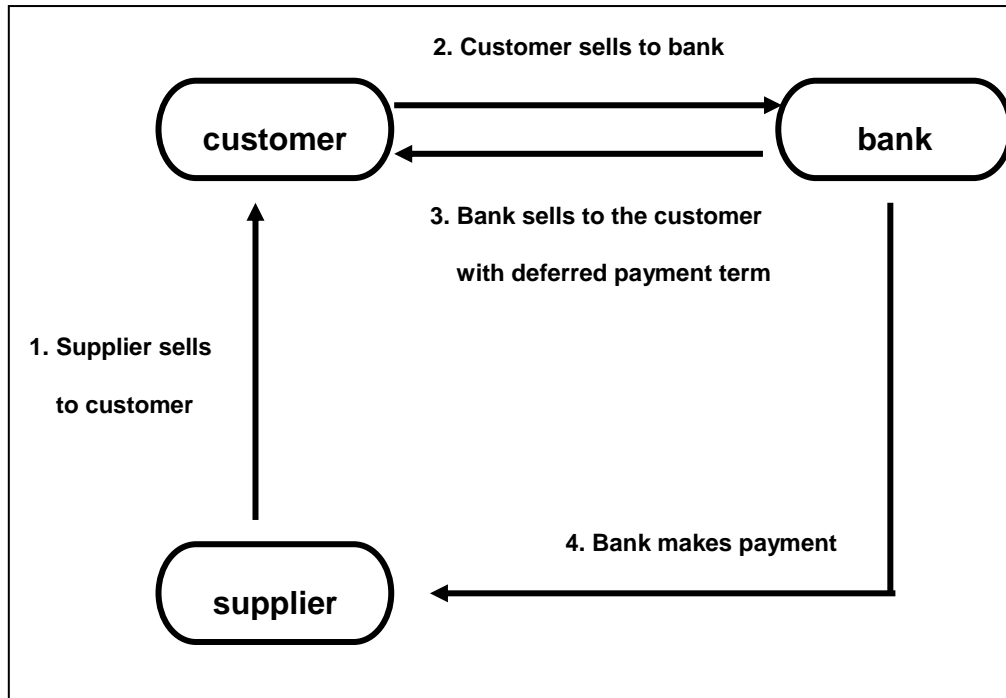

GST treatment on Murabahah financing .

SUPPLY	CONSIDERATION	GST TREATMENT
1. supply of the asset from supplier to the customer	cash payment made by bank	standard rated / exempted (e.g. commercial building or residential house)
2. supply of the asset when customer sells to bank	none	Non-supply
3. supply of service from bank to the customer with deferred payment facility	profits	Exempt

4. bank makes payment

No supply

Figure 2 :Structure of Musyarakah Mutanaqisah (financing without asset purchase).

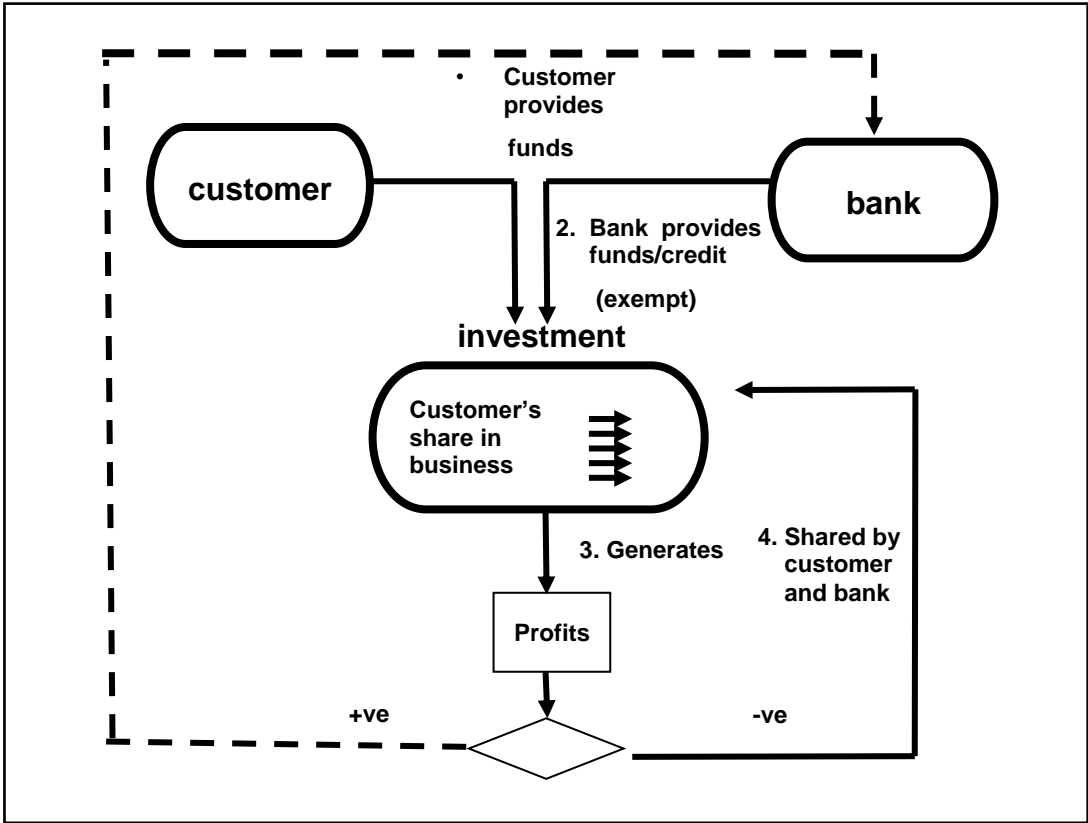

GST treatment to Musyarakah Mutanaqisah (financing without asset purchase)

SUPPLY	CONSIDERATION	GST TREATMENT
1. supply of the funds from the customer	none	non supply

2. supply of the credit from bank to profits exempt
the customer

Figure 3 : Structure of Musyarakah Mutanaqisah (financing with asset purchase)

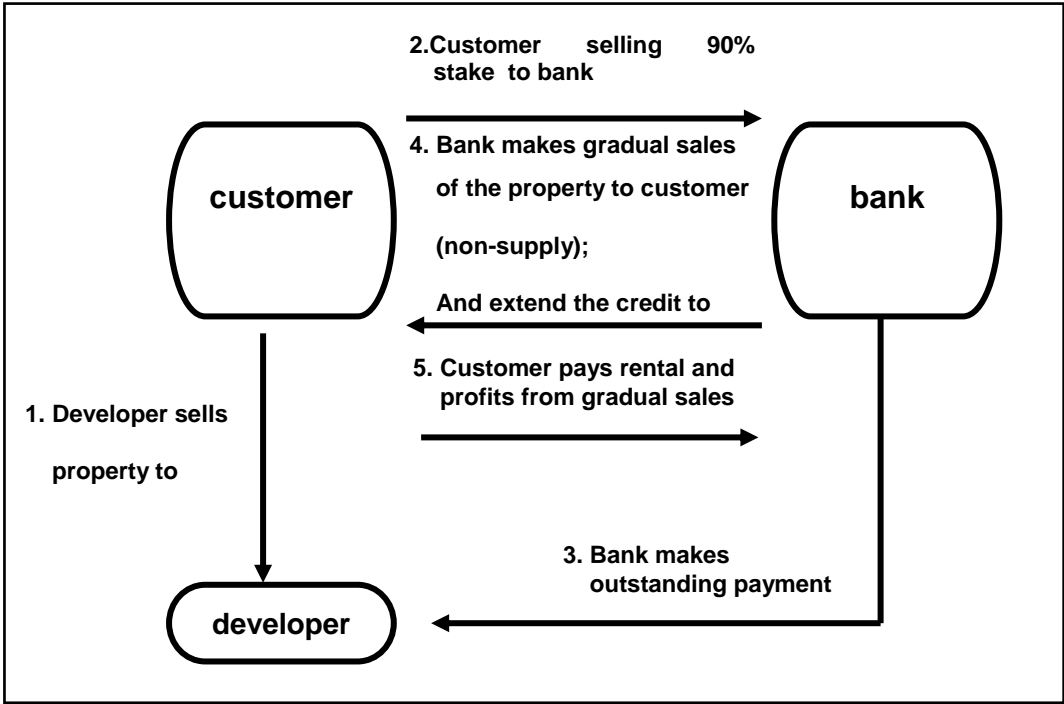

GST treatment to Musyarakah Mutanaqisah (financing with asset purchase)

SUPPLY	CONSIDERATION	GST TREATMENT
1. supply of the property made by developer to the customer	cash payment made by bank and customer	standard rated
2. customer selling the interest of the property to the bank	none	non supply

- | | | |
|--|----------------|------------|
| 3. supply of property by bank to the customer | price of goods | non-supply |
| 4. supply of credit facility by bank to the customer | profits | exempt |

Figure 4: Structure of Ijarah financing.

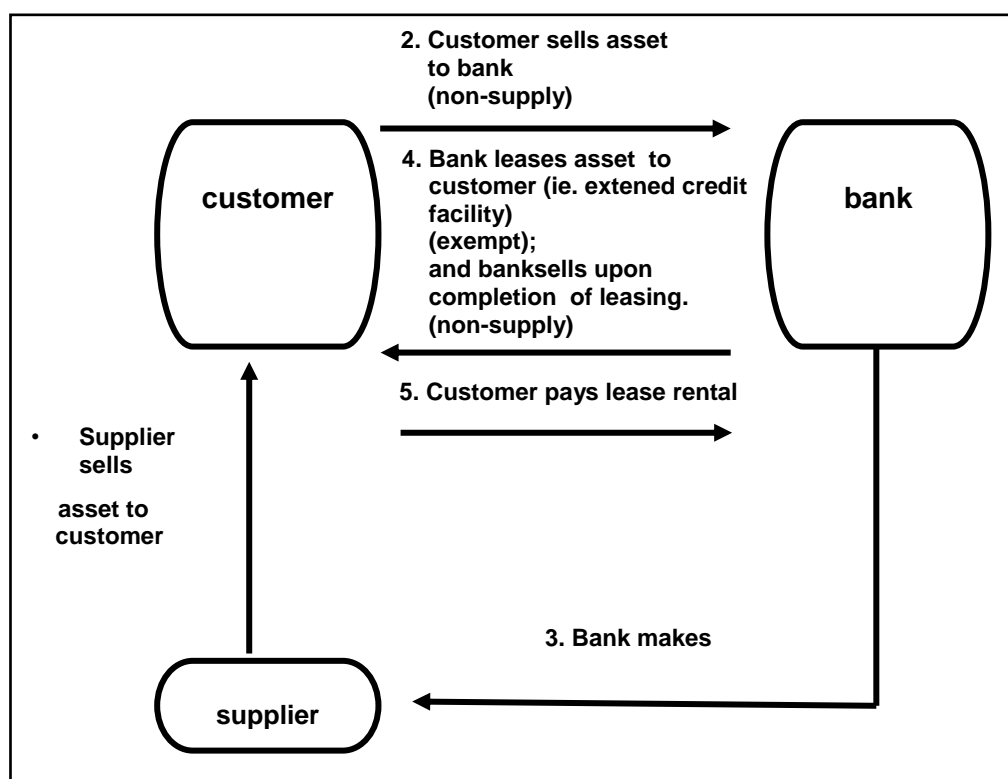

GST treatment on Ijarah Thumma Al Bai.

SUPPLY	CONSIDERATION	GST TREATMENT
1. supply of the asset made by developer to the customer	cash payment made by bank and customer	standard rated

- 2. supply of the asset customer sells to the bank none Non-supply
- 3. supply of goods from retailer to customer when the latter purchases payment made by bank standard rated
- 4. supply when customer makes payment to the bank merchant discount commission standard rated
- 5. supply of credit bank gives to customer profits/finance charges exempt

Figure 6: Structure of Wakalah

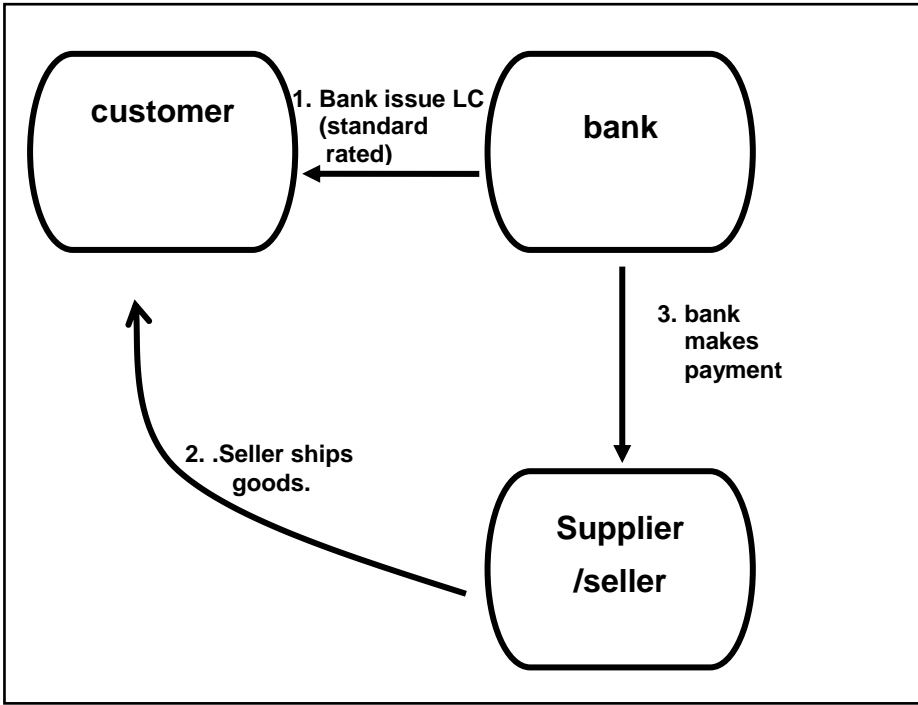

GST treatment on Wakalah.

SUPPLY	CONSIDERATION	GST TREATMENT
1. the issuance of Letter of Credit	commission	standard rated

Figure 7: Structure of Kafalah

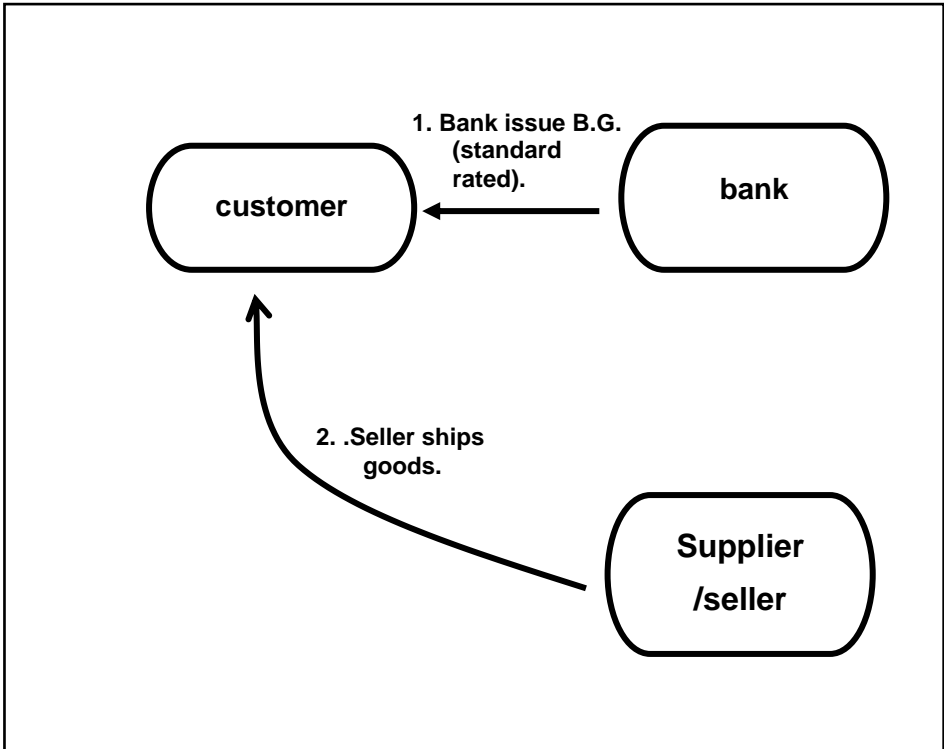

GST treatment on Kafalah.

SUPPLY	CONSIDERATION	GST TREATMENT
1. the issuance of Bank Guarantee	commission	standard rate
2. supply of credit of the bank to	profits	exempt

customer (in the case of default)

Figure 8 : Structure of Mudharabah

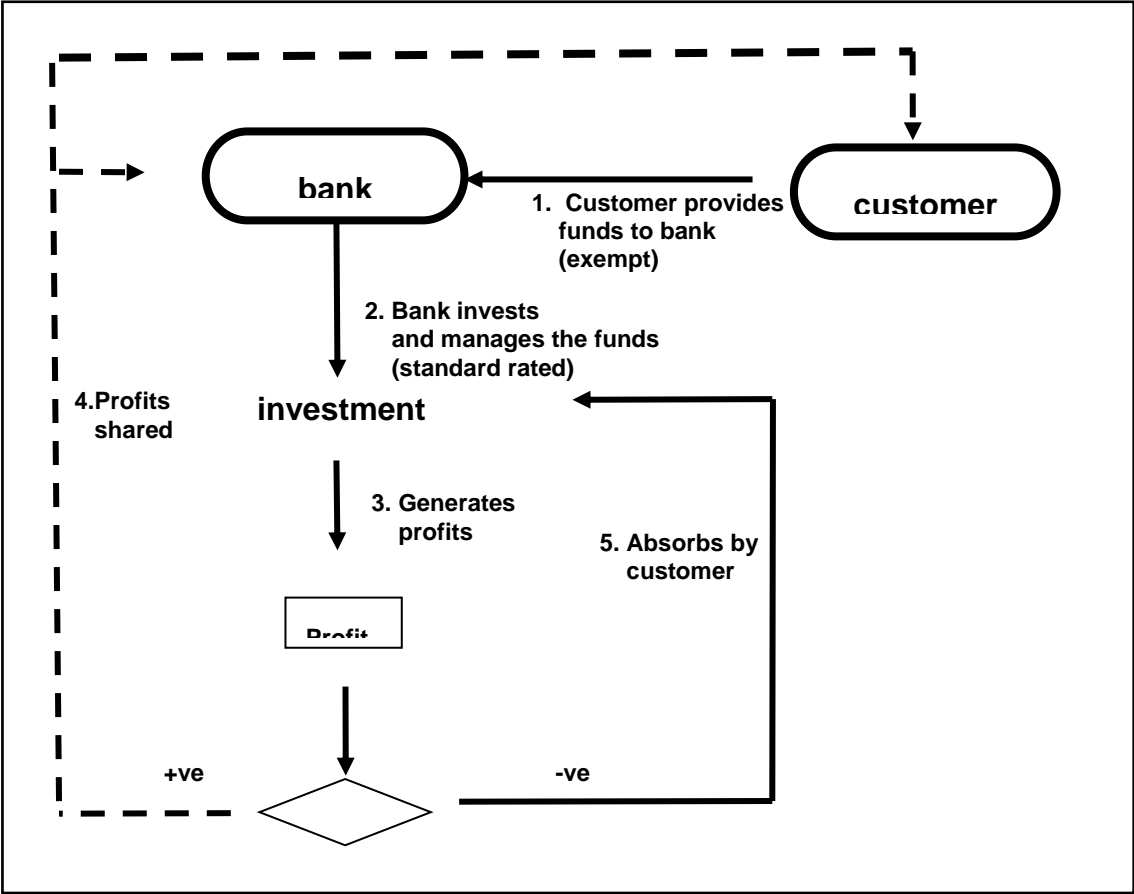

GST treatment on Mudharabah.

SUPPLY	CONSIDERATION	GST TREATMENT
1. supply of funds from the customer to bank	profits	exempt
2. supply service when bank manages the funds	fees	standard rated

Figure 9: Structure of Bai Al Dayn

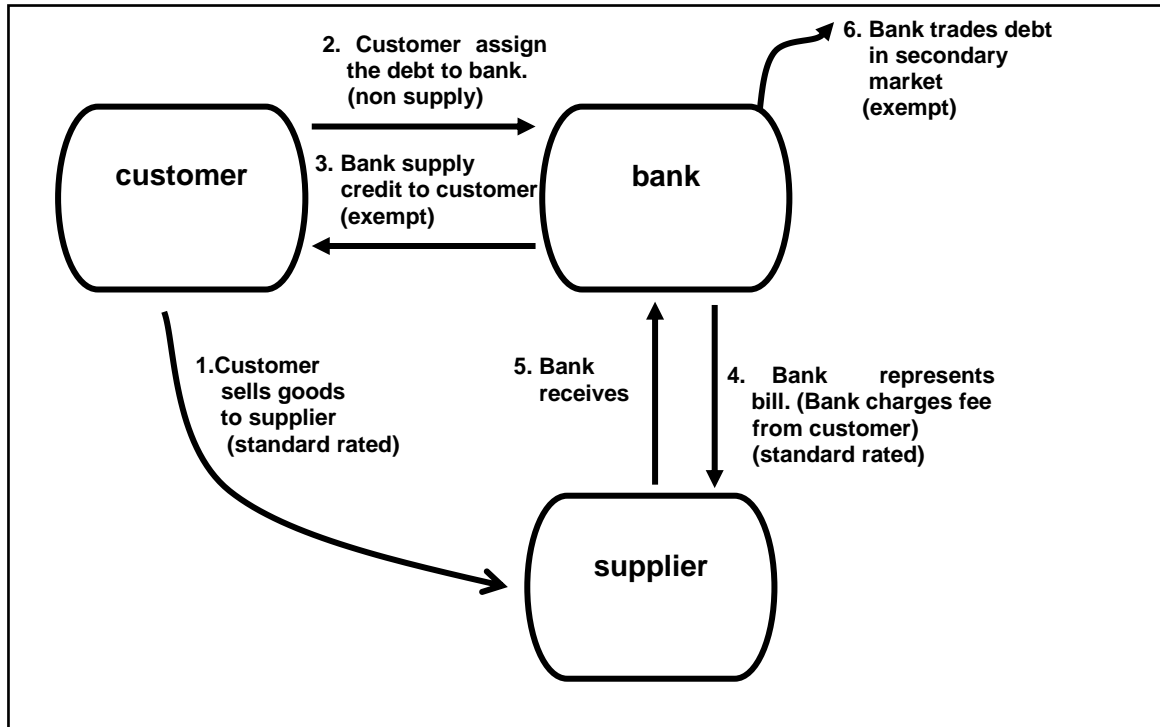

GST treatment on Bai Al Dayn.

SUPPLY	CONSIDERATION	GST TREATMENT
1. supply when customer sells asset to the supplier	value of asset	standard rated
2. supply of customer assign the debt to bank	payment	non supply
3. supply of credit/financing from bank to the customer	profits	exempt
4. supply of service when recovers the account receivables	fee	standard rated
5. bank trades debt in secondary market (subsequent sales)	value	exempt

Figure 10: Structure of Wadiah

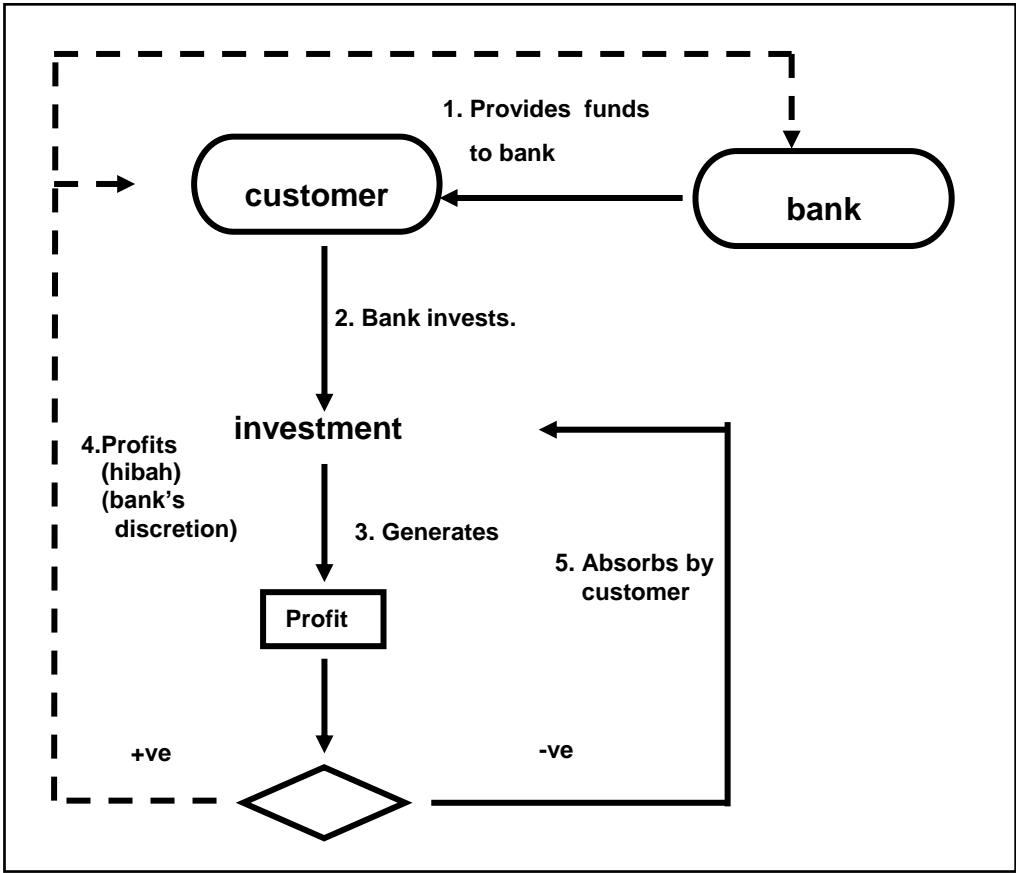

GST treatment on Wadiah.

SUPPLY	CONSIDERATION	GST TREATMENT
1. supply of the deposits from the customer.	profits	exempt